

FEATURES:

- Architectural luminaire with direct lighting distribution.
- Light source: LED Strip.
- Diffused illumination is provided by high efficiency opal lens.
- Sleek body of the luminaire combines aluminium profile with laser cut metal top enclosure.
- Magnetic sides provide option of tool free connection between individual fixtures to create custom shapes and design configurations.
- Suitable for suspended or surface installations.
- Build in driver is powered by unique plug in system.
- LED Strips are rated for 60,000hrs. L70 and +85CRI.
- Has a proven record in office and commercial installations.
- Custom modifications are available.

design: Rob van Beek

SPECIFICATION: ED MILA+

SOURCE	VOLTAGE	DRIVER	MOUNTING	FINISH	CCT
20W LED	120V	ST - Standard	SS - Suspended	WH - White	30K - 3000Kelvin
40W LED	277V	DL - 0.10V Dimming	SF - Surface	GR - Grey	35K - 3500Kelvin
	347V*	DM - Dimming**		BK - Black	40K - 4000Kelvin

* Not available for all configurations.
 ** Please specify dimming requirements.

EXAMPLES:

1. ED MILA+20W LED-120V-ST-SF-OP-GR-30K
2. ED MILA+40W LED-120V-DM/DALI-SS-OP-WH-40K

LUMEN OUTPUT:

Watts	30K	35K	40K
20W	2100 lm	2150 lm	2200 lm
40W	4200 lm	4300 lm	4400 lm

Project:

Type:

Edison Lighting Group Ltd.

1303 Ringwell Dr. Unit #2, Newmarket, ON L3Y 8T9
 Tel: 905-830-0339 or 1-800-667-9281 Fax: 905-898-6439 or 1-800-667-9302
www.edisonlighting.ca info@edisonlighting.ca

SIZE:

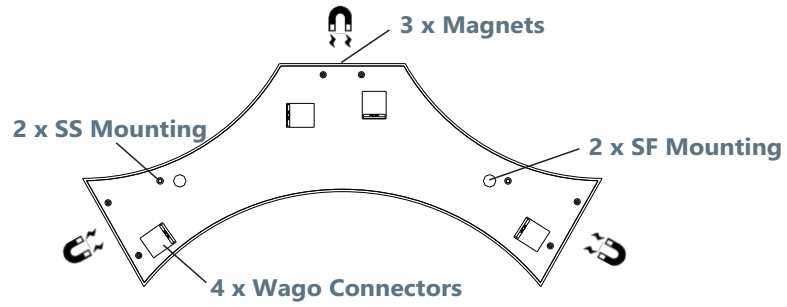
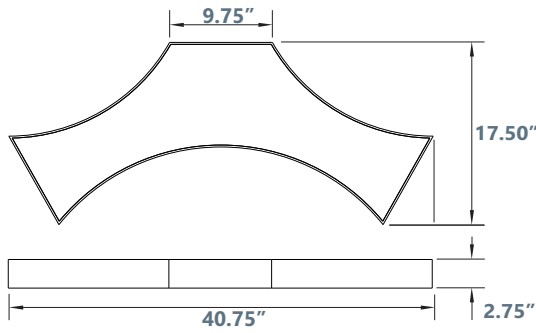

MOUNTING:

Suspended

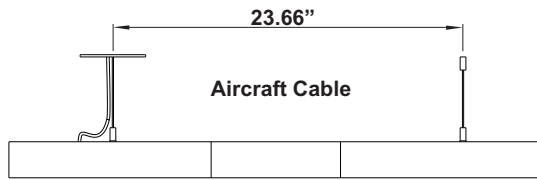

Surface

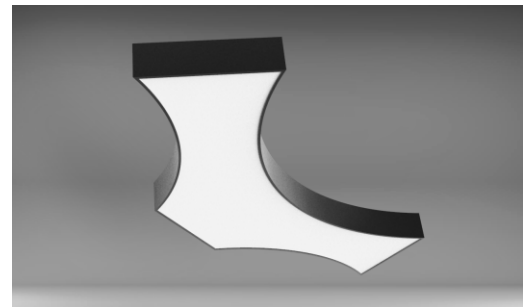
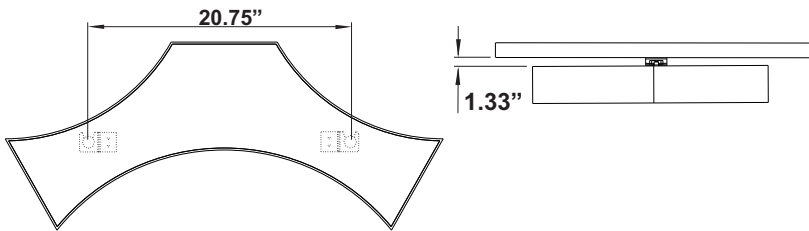

Connection

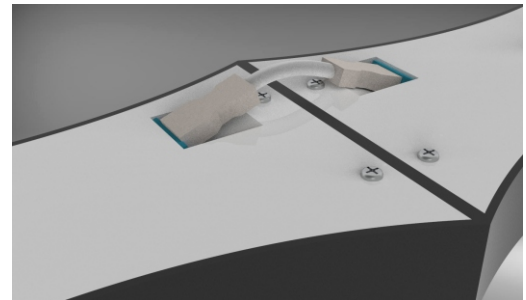
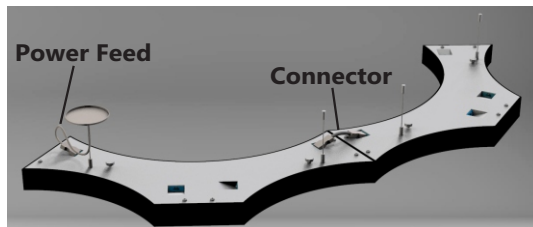

Options

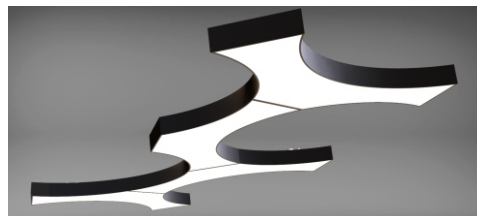
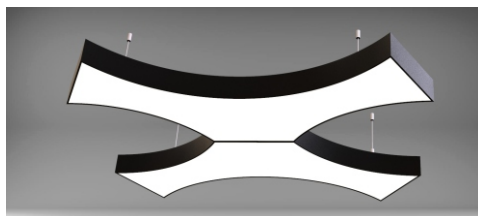

Edison Lighting Group Ltd.

1303 Ringwell Dr. Unit #2, Newmarket, ON L3Y 8T9

Tel: 905-830-0339 or 1-800-667-9281 Fax: 905-898-6439 or 1-800-667-9302

www.edisonlighting.ca info@edisonlighting.ca

Specifications are subject to change without notice. Every effort has been made for accuracy, and errors are unintentional.