

FEATURES:

- ✓ Architectural sound absorbing Eco Felt Acoustic panel.
- ✓ Polyester material made from 70% recyclable plastic.
- ✓ Available in various shapes and sizes.
- ✓ Lightweight panel comes with standard 20 color options.
- ✓ Layering or wood grain print decals are available.
- ✓ Customized 2D or 3D pattern designs and shapes.
- ✓ Class 1 Fire Rated with 0.7 Noise Reduction Coefficient / 1" Acoustic.
- ✓ Suitable for suspended, wall or ceiling installations.
- ✓ Has a proven record in office, commercial and hospitality environments.

reinventlight

SPECIFICATION:

Sonic BAFFLE TYPE — HEIGHT — SIZE — SHAPE — MOUNTING — FINISH

Enter the Product Code into the boxes above.

TYPE

- HB - Horizontal Baffle

HEIGHT

- A - 1/2 in
 - B - 1 in
 -
- Specify custom height.

SIZE

- 2 ft
 - 3 ft
 - 4 ft
 -
- Specify custom size

SHAPE

- CR - Circle
 - SQ - Square
 - TR - Triangle
 - HE - Hexagon
 - RC - Rectangle
 - OV - Oval
 - CS -
- Specify custom shape.

MOUNTING

- S6-Suspension 6 ft
 - S ¹
 - WM - Wall Mount ²
 - SF - Surface Mount ²
1. Specify required Length.
2. PL Premium Adhesive or Double Sided Tape supplied by others.

ACOUSTIC FINISH

Please specify finishes.



Project:

Type:



SIZE:

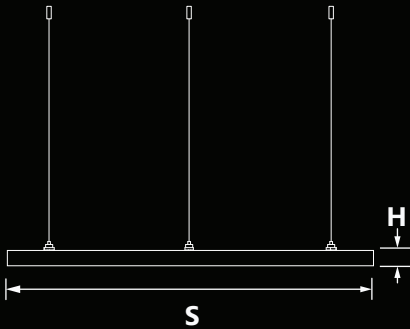

H-Height	S-Size
A - 1/2 in	2 ft = 23.75 in
B - 1 in	3 ft = 35.75 in
	4 ft = 47.75 in

MOUNTING:

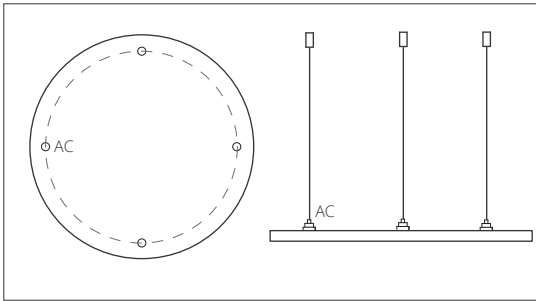

SUSPENDED
AC - Aircraft Cable.

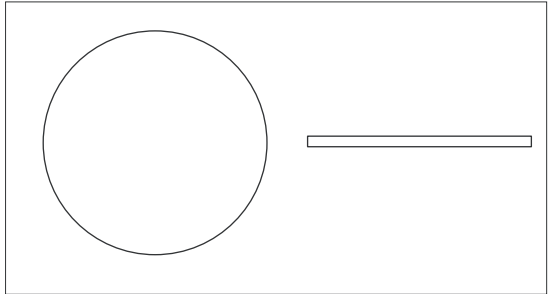

CEILING/WALL MOUNT
PL Premium Adhesive or Double Sided Tape applied.

SHAPE:

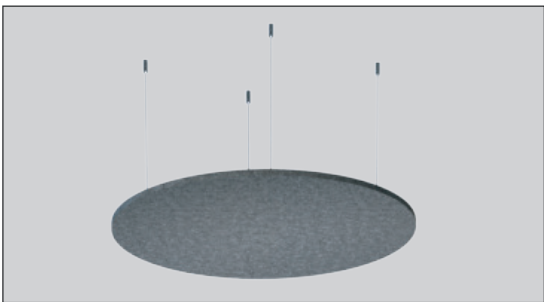

CR - CIRCLE #04

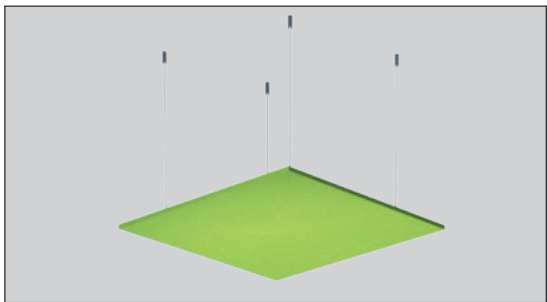

SQ - SQUARE #15

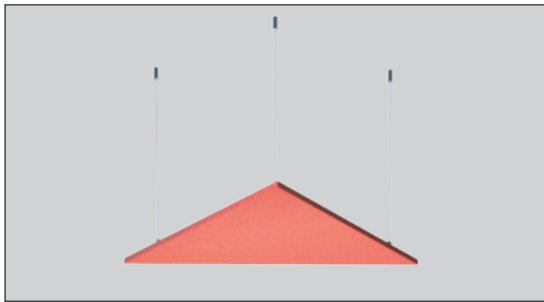

TR - TRIANGLE #25

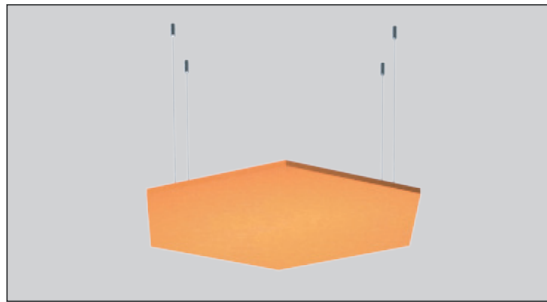

HE - HEXAGON #06